

Fat Sterilizer



Function:

The Mavitec Fat Sterilizing system is an automated batch system which can be supplied with various capacities. It's developed to work according to EU Commission regulation No. 142/2011 which implements EC Regulation 1069/2009.

Features:

- The Fat Sterilizing system; charging, heating, pressurization, retention time, pressure release and discharging, is done in an automated cycle
- Minimum human interference is required, while the required parameters are monitored and controlled
- Process data are logged for quality control and veterinarian inspections
- The process operates at a temperature more than 133° for at least 20 minutes at an absolute pressure of 3 bar, according to Method 1; Pressure Sterilization

Capacity / Range: 1 – 10 ton per hour



MAVITEC

Fat Sterilizer

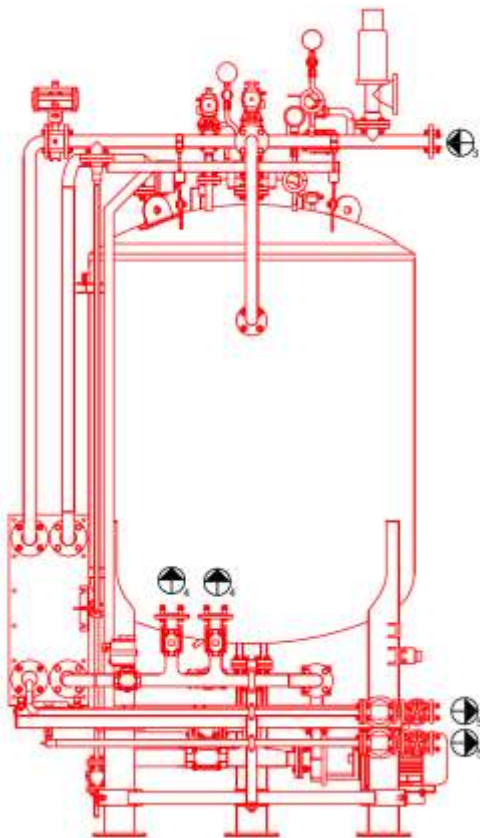
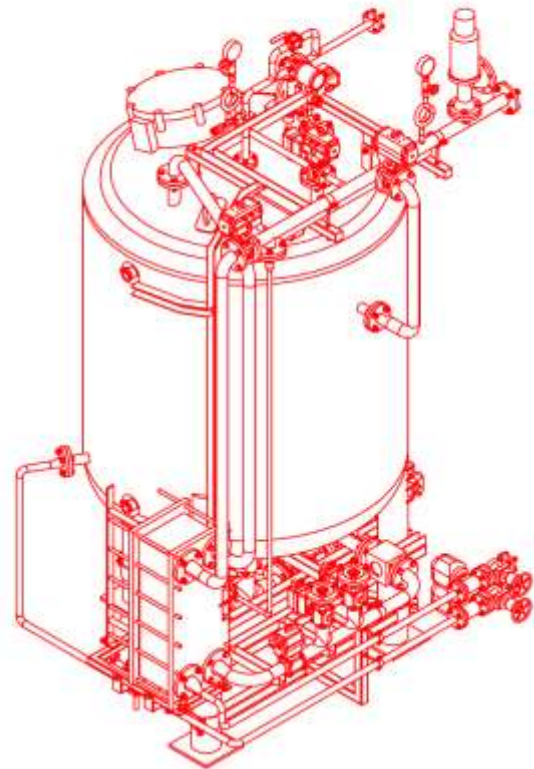
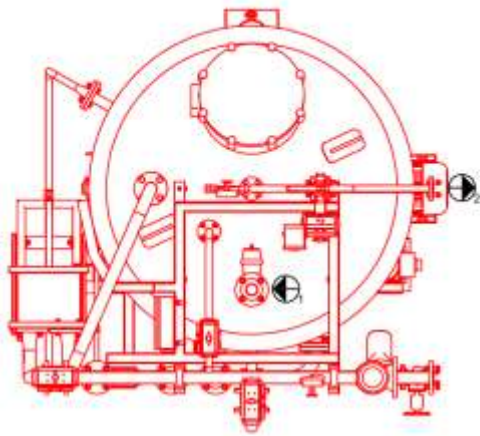

	INLET	FAT	
	OUTLET	VENT	
	INLET	STEAM 4 BAR	
	OUTLET	FAT	
	OUTLET	CONDENSATE	

Due to ongoing product improvements, data shown here is subject to change without notice. Contact Mavitec B.V. for latest specifications.

Due to ongoing product improvements, data shown here is subject to change without notice.
Contact Mavitec B.V. for latest specifications.

MAVITEC

Galileistraat 32, 1704 SE Heerhugowaard, The Netherlands
Tel.: +31-72-574 59 88 - Fax: +31-72-574 55 48
E-mail: info@mavitec.com - www.mavitec.com